

# MINI MCR-2-V8-MOD-RTU - Communication module



2905634

<https://www.phoenixcontact.com/us/products/2905634>

Please be informed that the data shown in this PDF document is generated from our online catalog. Please find the complete data in the user documentation. Our general terms of use for downloads are valid.



Eight MINI Analog Pro signal conditioners and measuring transducers are quickly and easily integrated into a Modbus/RTU network via a communication adapter.

## Product description

Thanks to its innovative plug-in concept, the communication adapter offers a time-saving wiring solution. Eight MINI Analog Pro signal converters can be quickly and easily integrated into a Modbus/RTU network using a communication adapter. Flexible signal combinations and eliminating the need for I/O input cards saves space and money in the control cabinet.

## Commercial data

Item number	2905634
Packing unit	1 pc
Minimum order quantity	1 pc
Sales key	C404
Product key	CK14ZZ
Catalog page	Page 100 (C-5-2019)
GTIN	4046356997119
Weight per piece (including packing)	199 g
Weight per piece (excluding packing)	199 g
Customs tariff number	85176200
Country of origin	DE

## Technical data

### Notes

#### Utilization restriction

EMC note	EMC: class A product, see manufacturer's declaration in the download area
----------	---

### Product properties

Product type	Communication module
Product family	MINI Analog Pro

#### Insulation characteristics: GB Standard

Overvoltage category	II
Pollution degree	2

### Electrical properties

Rated insulation voltage	50 V <sub>rms</sub>
Test voltage, input/output/supply	0.5 kV
Maximum temperature coefficient	0.01 %
Maximum transmission error	0.1 %

#### Supply

Nominal supply voltage range	12 V ... 24 V
Supply voltage range	9.6 V ... 30 V
Typical current consumption	110 mA (9.6 V DC)
Power consumption	< 1000 mW

### Input data

Available input sources	floating switch contact
	Current source
Number of inputs	8
Configurable/programmable	Yes
Current input signal	4 mA ... 20 mA
Maximum input current	24 mA
Input resistance current input	50 Ω
Maximum input voltage	5 V

### Output data

Protocols supported	Modbus/RTU
Number of outputs	1
Configurable/programmable	Yes
Transmission speed	1.2 kbps
	2.4 kbps
	4.8 kbps

# MINI MCR-2-V8-MOD-RTU - Communication module



2905634

<https://www.phoenixcontact.com/us/products/2905634>

	9.6 kbps
	19.2 kbps
	38.4 kbps
	57.6 kbps
	115.2 kbps
Data update rate	15 ms

## Connection data

### Output

Connection method	D-SUB socket strip
Number of positions	9

## Ex data

Ex installation (EPL)	Gc
	Div. 2

## Signaling

Status display	Green LED
Error indication	Red LED

## Dimensions

Width	51.1 mm
Height	104.1 mm
Depth	56.8 mm

## Material specifications

Housing material	PBT 7% GF V0
------------------	--------------

## Environmental and real-life conditions

### Ambient conditions

Degree of protection	IP20 (Finger safety)
Ambient temperature (operation)	-40 °C ... 65 °C
Ambient temperature (storage/transport)	-40 °C ... 70 °C
Altitude	4000 m
Permissible humidity (operation)	5 % ... 95 %
Permissible humidity (storage/transport)	5 % ... 95 %

## Approvals

### CE

Certificate	CE-compliant
-------------	--------------

### ATEX

Identification	⊕ II 3 G Ex ec IIC T4 Gc
Certificate	BVS 21 ATEX E 064 X

# MINI MCR-2-V8-MOD-RTU - Communication module



2905634

<https://www.phoenixcontact.com/us/products/2905634>

## UKCA Ex (UKEX)

Identification	Ⓜ II 3 G Ex ec IIC T4 Gc
Certificate	PxCIF21UKEX2905634X

## IECEX

Identification	Ex ec IIC T4 Gc
Certificate	IECEX BVS 21.0071X

## CCC / China-Ex

Identification	Ex ec IIC T4 Gc
Certificate	2022122308115724

## UL, USA/Canada

Identification	UL 508 Listed
	Class I, Div. 2, Groups A, B, C, D T5
	Class I, Zone 2, Group IIC T5

## EAC Ex

Identification	Ⓜ Ex ec IIC T4 Gc
Certificate	BY/112 02.01 TP012 103.01 00081

## EMC data

Noise immunity	EN 61000-6-2
Note	When being exposed to interference, there may be minimal deviations.
Electromagnetic compatibility	Conformance with EMC directive
Noise emission	EN 61000-6-4

## Standards and regulations

### GB Standard

Standards/regulations	GB/T 3836.1
	GB/T 3836.3

## Mounting

Mounting type	Plug-on assembly
Mounting position	any

## Drawings

Block diagram

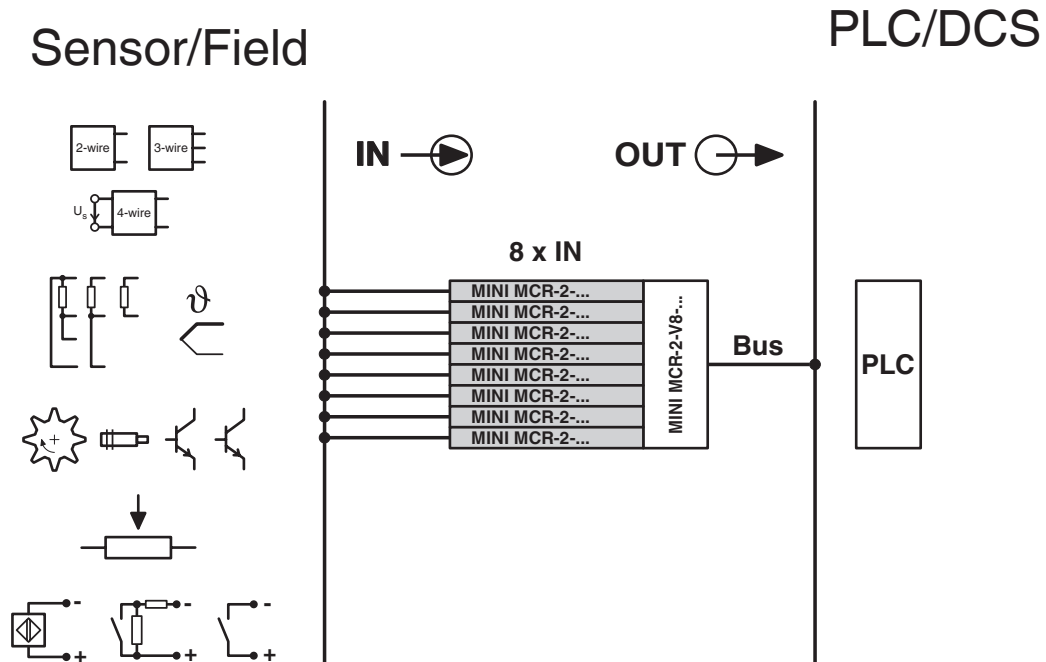

2905634

<https://www.phoenixcontact.com/us/products/2905634>

## Approvals

To download certificates, visit the product detail page: <https://www.phoenixcontact.com/us/products/2905634>



**EAC**

Approval ID: RU\*DE.\*08.B.01518/19



**UL Listed**

Approval ID: FILE E 238705



**cUL Listed**

Approval ID: FILE E 238705



**cUL Listed**

Approval ID: FILE E 196811



**UL Listed**

Approval ID: FILE E 196811

**cULus Listed**

**cULus Listed**

# MINI MCR-2-V8-MOD-RTU - Communication module



2905634

<https://www.phoenixcontact.com/us/products/2905634>

## Classifications

### ECLASS

ECLASS-11.0	27242608
ECLASS-12.0	27242608
ECLASS-13.0	27242608

### ETIM

ETIM 9.0	EC001604
----------	----------

### UNSPSC

UNSPSC 21.0	32151600
-------------	----------

# MINI MCR-2-V8-MOD-RTU - Communication module



2905634

<https://www.phoenixcontact.com/us/products/2905634>

## Environmental product compliance

REACH SVHC	Lead 7439-92-1
China RoHS	Environmentally Friendly Use Period = 50 years
	For information on hazardous substances, refer to the manufacturer's declaration available under "Downloads"



# MINI MCR-2-V8-MOD-RTU - Communication module



2905634

<https://www.phoenixcontact.com/us/products/2905634>

## Accessories

### MINI MCR-2-PTB - Power terminal block

2902066

<https://www.phoenixcontact.com/us/products/2902066>



Power terminal with plug-in connection technology for delivering the supply voltage to the DIN rail connector. Monitoring of the supply voltages in combination with the fault monitoring module. Screw connection technology

---

### MINI MCR-2-PTB-PT - Power terminal block

2902067

<https://www.phoenixcontact.com/us/products/2902067>



Power terminal with plug-in connection technology for delivering the supply voltage to the DIN rail connector. Monitoring of the supply voltages in combination with the fault monitoring module. Push-in connection technology

# MINI MCR-2-V8-MOD-RTU - Communication module



2905634

<https://www.phoenixcontact.com/us/products/2905634>

## MINI MCR-2-TB - Feed-through terminal block

2902068

<https://www.phoenixcontact.com/us/products/2902068>



Feed-through terminal block with plug-in connection technology for the transmission of signals already electrically isolated. Screw connection technology

---

## MINI MCR-2-FM-RC - Monitoring block

2904504

<https://www.phoenixcontact.com/us/products/2904504>



Fault monitoring module with plug-in connection technology for evaluating and reporting group errors from the FM system and for monitoring the supply voltages. Error message via N/C contact. Screw connection technology, standard configuration

# MINI MCR-2-V8-MOD-RTU - Communication module



2905634

<https://www.phoenixcontact.com/us/products/2905634>

## MINI MCR-2-FM-RC-PT - Monitoring block

2904508

<https://www.phoenixcontact.com/us/products/2904508>

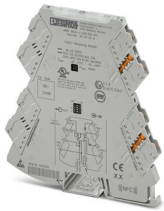

Fault monitoring module with plug-in connection technology for evaluating and reporting group errors from the FM system and for monitoring the supply voltages. Error message via N/C contact. Push-in connection technology, standard configuration

---

## MINI MCR-2-UNI-UI-UIRO-PT - Signal conditioner

2902028

<https://www.phoenixcontact.com/us/products/2902028>



Universally configurable 4-way signal conditioner, with switching output and plug-in connection technology for the electrical isolation of analog signals. Configurable via DIP switch or software. Push-in connection technology, standard configuration.

# MINI MCR-2-V8-MOD-RTU - Communication module



2905634

<https://www.phoenixcontact.com/us/products/2905634>

## MINI MCR-2-UNI-UI-UIRO - Signal conditioner

2902026

<https://www.phoenixcontact.com/us/products/2902026>



Universally configurable 4-way signal conditioner, with switching output and plug-in connection technology for the electrical isolation of analog signals. Configurable via DIP switch or software. Screw connection technology, standard configuration.

---

## MINI MCR-2-UNI-UI-UIRO-PT-C - Signal conditioner

2902027

<https://www.phoenixcontact.com/us/products/2902027>



Universally configurable 4-way signal conditioner, with switching output and plug-in connection technology for the electrical isolation of analog signals. Configurable via DIP switch or software. Push-in connection technology, order configuration.

# MINI MCR-2-V8-MOD-RTU - Communication module



2905634

<https://www.phoenixcontact.com/us/products/2905634>

## MINI MCR-2-UNI-UI-UIRO-C - Signal conditioner

2902024

<https://www.phoenixcontact.com/us/products/2902024>



Universally configurable 4-way signal conditioner, with switching output and plug-in connection technology for the electrical isolation of analog signals. Configurable via DIP switch or software. Screw connection technology, order configuration.

---

## MINI MCR-2-UI-UI-PT - Signal conditioner

2902040

<https://www.phoenixcontact.com/us/products/2902040>



3-way signal conditioner with plug-in connection technology and calibrated measuring range changeover, for the electrical isolation of unipolar and bipolar analog signals. Input/output configurable via DIP switch. push-in connection technology, standard configuration.

# MINI MCR-2-V8-MOD-RTU - Communication module



2905634

<https://www.phoenixcontact.com/us/products/2905634>

## MINI MCR-2-UI-UI - Signal conditioner

2902037

<https://www.phoenixcontact.com/us/products/2902037>

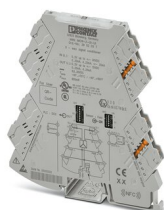

3-way signal conditioner with plug-in connection technology and calibrated measuring range changeover for the electrical isolation of unipolar and bipolar analog signals. Input/output configurable via DIP switch. Screw connection technology, standard configuration.

---

## MINI MCR-2-UI-UI-PT-C - Signal conditioner

2902039

<https://www.phoenixcontact.com/us/products/2902039>



3-way signal conditioner with plug-in connection technology and calibrated measuring range changeover for the electrical isolation of unipolar and bipolar analog signals. Input/output configurable via DIP switch. push-in connection technology, order configuration.

# MINI MCR-2-V8-MOD-RTU - Communication module



2905634

<https://www.phoenixcontact.com/us/products/2905634>

## MINI MCR-2-UI-UI-C - Signal conditioner

2902036

<https://www.phoenixcontact.com/us/products/2902036>

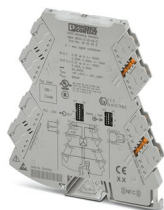

3-way signal conditioner with plug-in connection technology and calibrated measuring range changeover for the electrical isolation of unipolar and bipolar analog signals. Input/output configurable via DIP switch. Screw connection technology, order configuration.

---

## MINI MCR-2-U-UI-PT - Signal conditioner

2902021

<https://www.phoenixcontact.com/us/products/2902021>



3-way signal conditioner, with configurable input/output, for electrical isolation and conversion of analog signals in the mV and V range, unipolar as well as bipolar. Push-in connection technology, standard configuration.

# MINI MCR-2-V8-MOD-RTU - Communication module



2905634

<https://www.phoenixcontact.com/us/products/2905634>

## MINI MCR-2-U-UI - Signal conditioner

2902019

<https://www.phoenixcontact.com/us/products/2902019>



3-way signal conditioner, with configurable input/output, for electrical isolation and conversion of analog signals in the mV and V range, unipolar as well as bipolar. Screw connection technology, standard configuration.

---

## MINI MCR-2-U-I0-PT - Signal conditioner

2902023

<https://www.phoenixcontact.com/us/products/2902023>



3-way signal conditioner with plug-in connection technology for the electrical isolation of analog signals. Input signal: 0 V ... 10 V, output signal: 0 mA ... 20 mA, push-in connection technology



# MINI MCR-2-V8-MOD-RTU - Communication module



2905634

<https://www.phoenixcontact.com/us/products/2905634>

## MINI MCR-2-U-I0 - Signal conditioner

2902022

<https://www.phoenixcontact.com/us/products/2902022>

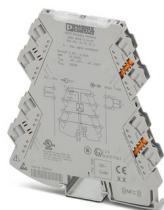

3-way signal conditioner with plug-in connection technology for the electrical isolation of analog signals. Input signal: 0 V ... 10 V, output signal: 0 mA ... 20 mA, screw connection technology

---

## MINI MCR-2-U-I4-PT - Signal conditioner

2902030

<https://www.phoenixcontact.com/us/products/2902030>



3-way signal conditioner with plug-in connection technology for the electrical isolation of analog signals. Input signal: 0 V ... 10 V, output signal: 4 mA ... 20 mA, push-in connection technology

# MINI MCR-2-V8-MOD-RTU - Communication module



2905634

<https://www.phoenixcontact.com/us/products/2905634>

## MINI MCR-2-U-I4 - Signal conditioner

2902029

<https://www.phoenixcontact.com/us/products/2902029>

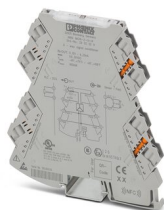

3-way signal conditioner with plug-in connection technology for the electrical isolation of analog signals. Input signal: 0 V ... 10 V, output signal: 4 mA ... 20 mA, screw connection technology

---

## MINI MCR-2-I-I-PT - Signal conditioner

2901999

<https://www.phoenixcontact.com/us/products/2901999>



3-way signal conditioner with plug-in connection technology for the electrical isolation of analog signals. Input signal: 0(4) mA ... 20 mA, output signal: 0(4) mA ... 20 mA, push-in connection technology.

## MINI MCR-2-V8-MOD-RTU - Communication module

2905634

<https://www.phoenixcontact.com/us/products/2905634>



## MINI MCR-2-I-I - Signal conditioner

2901998

<https://www.phoenixcontact.com/us/products/2901998>

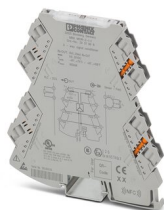

3-way signal conditioner with plug-in connection technology for the electrical isolation of analog signals. Input signal: 0(4) mA ... 20 mA, output signal: 0(4) mA ... 20 mA, screw connection technology

---

## MINI MCR-2-UNI-UI-2UI-PT - Signal duplicator

2905028

<https://www.phoenixcontact.com/us/products/2905028>



Universally configurable 4-way signal duplicator, with plug-in connection technology for the electrical isolation and duplication of analog signals. Configurable via DIP switch or software. Push-in connection technology, standard configuration.

# MINI MCR-2-V8-MOD-RTU - Communication module



2905634

<https://www.phoenixcontact.com/us/products/2905634>

## MINI MCR-2-UNI-UI-2UI - Signal duplicator

2905026

<https://www.phoenixcontact.com/us/products/2905026>



Universally configurable 4-way signal duplicator, with plug-in connection technology for the electrical isolation and duplication of analog signals. Configurable via DIP switch or software. Screw connection technology, standard configuration.

---

## MINI MCR-2-UNI-UI-2UI-PT-C - Signal duplicator

2905027

<https://www.phoenixcontact.com/us/products/2905027>



Universally configurable 4-way signal duplicator, with plug-in connection technology for the electrical isolation and duplication of analog signals. Configurable via DIP switch or software. Push-in connection technology, order configuration.

# MINI MCR-2-V8-MOD-RTU - Communication module



2905634

<https://www.phoenixcontact.com/us/products/2905634>

## MINI MCR-2-UNI-UI-2UI-C - Signal duplicator

2905025

<https://www.phoenixcontact.com/us/products/2905025>



Universally configurable 4-way signal duplicator, with plug-in connection technology for the electrical isolation and duplication of analog signals. Configurable via DIP switch or software. Screw connection technology, order configuration.

---

## MINI MCR-2-RPSS-I-I-PT - Repeater power supply

2902015

<https://www.phoenixcontact.com/us/products/2902015>



3-way repeater power supply with plug-in connection technology. HART-transparent, input signal 0(4) mA ... 20 mA, output signal 0(4) mA ... 20 mA. The device can be used in both isolator and repeater power supply operation. push-in connection technology

# MINI MCR-2-V8-MOD-RTU - Communication module

2905634

<https://www.phoenixcontact.com/us/products/2905634>

## MINI MCR-2-RPSS-I-I - Repeater power supply

2902014

<https://www.phoenixcontact.com/us/products/2902014>



3-way repeater power supply with plug-in connection technology. HART-transparent, input signal 0(4)...20 mA, output signal 0(4)...20 mA. The device can be used in both isolator and repeater power supply operation. Screw connection technology

---

## MINI MCR-2-RPSS-I-2I-PT - Repeater power supply

2905629

<https://www.phoenixcontact.com/us/products/2905629>



4-way power supply doubler with plug-in connection technology. HART-transparent, 0(4) mA ... 20 mA input signal, 0(4) mA ... 20 mA output signals. The device can be used in both signal and power supply doubler modes. Push-in connection technology.

# MINI MCR-2-V8-MOD-RTU - Communication module



2905634

<https://www.phoenixcontact.com/us/products/2905634>

## MINI MCR-2-RPSS-I-2I - Repeater power supply

2905628

<https://www.phoenixcontact.com/us/products/2905628>

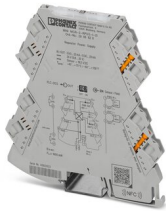

4-way power supply doubler with plug-in connection technology. HART-transparent, 0(4) mA ... 20 mA input signal, 0(4) mA ... 20 mA output signals. The device can be used in both signal and power supply doubler modes. Screw connection technology.

---

## MINI MCR-2-I-I-ILP-PT - Loop-powered isolators

2901995

<https://www.phoenixcontact.com/us/products/2901995>



1-channel input loop-powered 2-way isolator with plug-in connection technology for the electrical isolation of analog signals. Input signal = output signal: 0(4) mA ... 20 mA. Push-in connection technology.

# MINI MCR-2-V8-MOD-RTU - Communication module



2905634

<https://www.phoenixcontact.com/us/products/2905634>

## MINI MCR-2-I-I-ILP - Loop-powered isolators

2901994

<https://www.phoenixcontact.com/us/products/2901994>



1-channel input loop-powered 2-way isolator with plug-in connection technology for the electrical isolation of analog signals. Input signal = output signal: 0(4) mA ... 20 mA. Screw connection technology.

---

## MINI MCR-2-RTD-UI-PT - Resistance thermometer measuring transducer

2902052

<https://www.phoenixcontact.com/us/products/2902052>



Configurable temperature transducer with plug-in connection technology for connecting 2, 3, and 4-conductor resistance thermometers and resistance-type sensors. Configurable via DIP switch or software. push-in connection technology, standard configuration



# MINI MCR-2-V8-MOD-RTU - Communication module



2905634

<https://www.phoenixcontact.com/us/products/2905634>

## MINI MCR-2-RTD-UI - Resistance thermometer measuring transducer

2902049

<https://www.phoenixcontact.com/us/products/2902049>



Configurable temperature transducer with plug-in connection technology for connecting 2, 3, and 4-conductor resistance thermometers and resistance-type sensors. Configurable via DIP switch or software. Screw connection technology, standard configuration

---

## MINI MCR-2-RTD-UI-PT-C - Resistance thermometer measuring transducer

2902051

<https://www.phoenixcontact.com/us/products/2902051>



Configurable temperature transducer with plug-in connection technology for connecting 2, 3, and 4-conductor resistance thermometers and resistance-type sensors. Configurable via DIP switch or software. push-in connection technology, order configuration

# MINI MCR-2-V8-MOD-RTU - Communication module



2905634

<https://www.phoenixcontact.com/us/products/2905634>

## MINI MCR-2-RTD-UI-C - Resistance thermometer measuring transducer

2902048

<https://www.phoenixcontact.com/us/products/2902048>



Configurable temperature transducer with plug-in connection technology for connecting 2, 3, and 4-conductor resistance thermometers and resistance-type sensors. Configurable via DIP switch or software. Screw connection technology, order configuration

---

## MINI MCR-2-TC-UI-PT - Thermocouple measuring transducer

2905249

<https://www.phoenixcontact.com/us/products/2905249>



Configurable temperature transducer with plug-in connection technology for connecting thermocouples. Configurable via DIP switch or software. Push-in connection technology, standard configuration

# MINI MCR-2-V8-MOD-RTU - Communication module



2905634

<https://www.phoenixcontact.com/us/products/2905634>

## MINI MCR-2-TC-UI - Thermocouple measuring transducer

2902055

<https://www.phoenixcontact.com/us/products/2902055>



Configurable temperature transducer with plug-in connection technology for connecting thermocouples. Configurable via DIP switch or software. Screw connection technology, standard configuration

---

## MINI MCR-2-TC-UI-PT-C - Thermocouple measuring transducer

2905248

<https://www.phoenixcontact.com/us/products/2905248>



Configurable temperature transducer with plug-in connection technology for connecting thermocouples. Configurable via DIP switch or software. Push-in connection technology, order configuration

## MINI MCR-2-V8-MOD-RTU - Communication module

2905634

<https://www.phoenixcontact.com/us/products/2905634>



## MINI MCR-2-TC-UI-C - Thermocouple measuring transducer

2902053

<https://www.phoenixcontact.com/us/products/2902053>



Configurable temperature transducer with plug-in connection technology for connecting thermocouples. Configurable via DIP switch or software. Screw connection technology, order configuration

---

## MINI MCR-2-T-REL-PT - Limit value switch

2905633

<https://www.phoenixcontact.com/us/products/2905633>

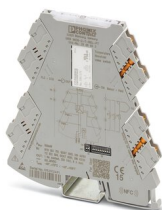

Universally configurable temperature limit value switch with N/O relay output for the connection of 2, 3, and 4-conductor resistance thermometers and thermocouples. Configurable via DIP switch or software. Push-in connection technology

## MINI MCR-2-V8-MOD-RTU - Communication module

2905634

<https://www.phoenixcontact.com/us/products/2905634>



## MINI MCR-2-T-REL - Limit value switch

2905632

<https://www.phoenixcontact.com/us/products/2905632>



Universally configurable temperature limit value switch with N/O relay output for the connection of 2, 3, and 4-conductor resistance thermometers and thermocouples. Configurable via DIP switch or software, screw connection technology

---

## MINI MCR-2-UI-FRO-PT - Frequency measuring transducer

2902032

<https://www.phoenixcontact.com/us/products/2902032>



Analog frequency transducer with limit value functionality and plug-in connection technology for converting standard signals into frequency or PWM signals. Configurable via DIP switch or software. Push-in connection technology, standard configuration.

# MINI MCR-2-V8-MOD-RTU - Communication module



2905634

<https://www.phoenixcontact.com/us/products/2905634>

## MINI MCR-2-UI-FRO - Frequency measuring transducer

2902031

<https://www.phoenixcontact.com/us/products/2902031>



Analog frequency transducer with limit value functionality and plug-in connection technology for converting standard signals into frequency or PWM signals. Configurable via DIP switch or software. Screw connection technology, standard configuration.

---

## MINI MCR-2-UI-FRO-PT-C - Frequency measuring transducer

2906202

<https://www.phoenixcontact.com/us/products/2906202>



Analog frequency transducer with limit value functionality and plug-in connection technology for converting standard signals into frequency or PWM signals. Configurable via DIP switch or software. Push-in connection technology, order configuration.

# MINI MCR-2-V8-MOD-RTU - Communication module



2905634

<https://www.phoenixcontact.com/us/products/2905634>

## MINI MCR-2-UI-FRO-C - Frequency measuring transducer

2906201

<https://www.phoenixcontact.com/us/products/2906201>



Analog frequency transducer with limit value functionality and plug-in connection technology for converting standard signals into frequency or PWM signals. Configurable via DIP switch or software. Screw connection technology, order configuration.

---

## MINI MCR-2-POT-UI-PT - Resistance/potiposition transducer

2902017

<https://www.phoenixcontact.com/us/products/2902017>



Configurable potiposition transducer with plug-in connection technology for connecting potentiometers from 0  $\Omega$  ... 100  $\Omega$  to 0 k $\Omega$  ... 100 k $\Omega$ . Configurable via DIP switch or software. push-in connection technology, standard configuration

# MINI MCR-2-V8-MOD-RTU - Communication module



2905634

<https://www.phoenixcontact.com/us/products/2905634>

## MINI MCR-2-POT-UI - Resistance/potiposition transducer

2902016

<https://www.phoenixcontact.com/us/products/2902016>



Configurable potiposition transducer with plug-in connection technology for connecting potentiometers from 0  $\Omega$  ... 100  $\Omega$  to 0 k $\Omega$  ... 100 k $\Omega$ . Configurable via DIP switch or software. Screw connection technology, standard configuration

---

## MINI MCR-2-POT-UI-PT-C - Resistance/potiposition transducer

2905006

<https://www.phoenixcontact.com/us/products/2905006>



Configurable potiposition transducer with plug-in connection technology for connecting potentiometers from 0  $\Omega$  ... 100  $\Omega$  to 0 k $\Omega$  ... 100 k $\Omega$ . Configurable via DIP switch or software. Push-in connection technology, order configuration



# MINI MCR-2-V8-MOD-RTU - Communication module



2905634

<https://www.phoenixcontact.com/us/products/2905634>

## MINI MCR-2-POT-UI-C - Resistance/potiposition transducer

2905005

<https://www.phoenixcontact.com/us/products/2905005>



Configurable potiposition transducer with plug-in connection technology for connecting potentiometers from 0  $\Omega$  ... 100  $\Omega$  to 0 k $\Omega$  ... 100 k $\Omega$ . Configurable via DIP switch or software. Screw connection technology, order configuration

---

## MINI MCR-2-NAM-2RO-PT - Isolation amplifier

2902005

<https://www.phoenixcontact.com/us/products/2902005>



Configurable NAMUR signal conditioner with plug-in connection technology for proximity sensors, floating switch contacts, and switch contacts with resistance circuit. 2 transistor outputs. Configurable via DIP switch. Push-in connection technology.

# MINI MCR-2-V8-MOD-RTU - Communication module



2905634

<https://www.phoenixcontact.com/us/products/2905634>

## MINI MCR-2-NAM-2RO - Isolation amplifier

2902004

<https://www.phoenixcontact.com/us/products/2902004>



Configurable NAMUR signal conditioner with plug-in connection technology for proximity sensors, floating switch contacts, and switch contacts with resistance circuit. 2 transistor outputs, configurable via DIP switch. Screw connection technology.

---

## MINI MCR-2-F-UI - Frequency measuring transducer

2902056

<https://www.phoenixcontact.com/us/products/2902056>



Universally configurable frequency transducer for converting frequency (Hz/rpm) and PWM signals into standard signals. Sensor voltages greater than 8.2 V DC are possible in combination with MINI MCR-2-SPS 1033202. Screw connection technology.

## MINI MCR-2-V8-MOD-RTU - Communication module

2905634

<https://www.phoenixcontact.com/us/products/2905634>



## MINI MCR-2-F-UI-PT - Frequency measuring transducer

2902058

<https://www.phoenixcontact.com/us/products/2902058>



Universally configurable frequency transducer for converting frequency (Hz/rpm) and PWM signals into standard signals. Sensor voltages greater than 8.2 V DC are possible in combination with MINI MCR-2-SPS-PT 1033201. Push-in connection technology.

---

## ME 6,2 TBUS-2 1,5/5-ST-3,81 GY - DIN rail bus connectors

2695439

<https://www.phoenixcontact.com/us/products/2695439>

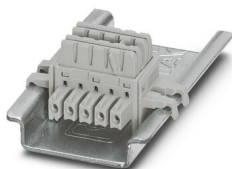

DIN rail connector (TBUS), 5-pos., for bridging the supply voltage, can be snapped onto NS 35/... DIN rail in accordance with EN 60715

# MINI MCR-2-V8-MOD-RTU - Communication module



2905634

<https://www.phoenixcontact.com/us/products/2905634>

## IFS-USB-PROG-ADAPTER - Programming adapter

2811271

<https://www.phoenixcontact.com/us/products/2811271>



Programming adapter with USB interface, for programming with software. The USB driver is included in the software solutions for the products to be programmed, such as measuring transducers or motor managers.

---

## ME 6,2 TBUS-2 1,5/5-ST-3,81 GN - DIN rail bus connectors

2869728

<https://www.phoenixcontact.com/us/products/2869728>

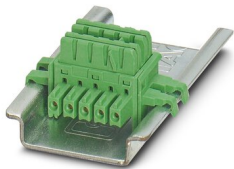

DIN rail connector for DIN rail mounting. Universal for TBUS housing. Gold-plated contacts, 5-pos.

# MINI MCR-2-V8-MOD-RTU - Communication module



2905634

<https://www.phoenixcontact.com/us/products/2905634>

## IFS-BT-PROG-ADAPTER - Adapter

2905872

<https://www.phoenixcontact.com/us/products/2905872>



Bluetooth adapter with micro USB and S-PORT interface for wireless communication with the MINI Analog, MINI Analog Pro, MACX Analog, Interface System Gateways, and PLC logic device series.

---

## TWN4 MIFARE NFC USB ADAPTER - Programming adapter

2909681

<https://www.phoenixcontact.com/us/products/2909681>



Near Field Communication (NFC) programming adapter with USB interface for the wireless configuration of NFC-capable products from Phoenix Contact with software. A separate USB driver is not required.

2905634

<https://www.phoenixcontact.com/us/products/2905634>

## UCT-EM (30X5) - Marker for end clamp

0801505

<https://www.phoenixcontact.com/us/products/0801505>



Marker for end clamp, Sheet, white, unlabeled, can be labeled with: TOPMARK NEO, TOPMARK LASER, BLUEMARK ID COLOR, BLUEMARK ID, BLUEMARK CLED, THERMOMARK PRIME, THERMOMARK CARD 2.0, THERMOMARK CARD, mounting type: snapped, lettering field size: 30 x 5 mm, Number of individual labels: 24

---

## UCT-EM (30X5) CUS - Marker for end clamp

0801589

<https://www.phoenixcontact.com/us/products/0801589>



Marker for end clamp, can be ordered: by sheet, white, labeled according to customer specifications, mounting type: snapped into marker carrier, lettering field size: 30 x 5 mm, Number of individual labels: 24

# MINI MCR-2-V8-MOD-RTU - Communication module



2905634

<https://www.phoenixcontact.com/us/products/2905634>

## SK 5,0 WH:REEL - Marker strip

0805221

<https://www.phoenixcontact.com/us/products/0805221>



Marker strip, Roll, white, unlabeled, can be labeled with: THERMOMARK E.300 (D)/600 (D), THERMOMARK ROLL 2.0, THERMOMARK ROLL, THERMOMARK ROLL X1, THERMOMARK ROLLMASTER 300/600, THERMOMARK X1.2, mounting type: adhesive, lettering field size: continuous x 5 mm, Number of individual labels: 10

---

## UC-EMLP (15X5) - Plastic label

0819301

<https://www.phoenixcontact.com/us/products/0819301>



Plastic label, Sheet, white, unlabeled, can be labeled with: BLUEMARK ID COLOR, BLUEMARK ID, BLUEMARK CLED, PLOTMARK, CMS-P1-PLOTTER, mounting type: adhesive, lettering field size: 15 x 5 mm, Number of individual labels: 10

# MINI MCR-2-V8-MOD-RTU - Communication module



2905634

<https://www.phoenixcontact.com/us/products/2905634>

## UC-EMLP (15X5) YE - Plastic label

0822615

<https://www.phoenixcontact.com/us/products/0822615>

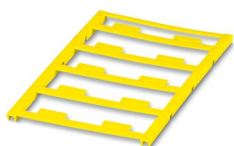

Plastic label, Sheet, yellow, unlabeled, can be labeled with: BLUEMARK ID COLOR, BLUEMARK ID, BLUEMARK CLED, PLOTMARK, CMS-P1-PLOTTER, mounting type: adhesive, lettering field size: 15 x 5 mm, Number of individual labels: 10

---

## UC-EMLP (15X5) CUS - Plastic label

0824550

<https://www.phoenixcontact.com/us/products/0824550>



Plastic label, can be ordered: by sheet, white, labeled according to customer specifications, mounting type: adhesive, lettering field size: 15 x 5 mm



# MINI MCR-2-V8-MOD-RTU - Communication module



2905634

<https://www.phoenixcontact.com/us/products/2905634>

## UC-EMLP (15X5) YE CUS - Plastic label

0824551

<https://www.phoenixcontact.com/us/products/0824551>

Plastic label, can be ordered: by sheet, yellow, labeled according to customer specifications, mounting type: adhesive, lettering field size: 15 x 5 mm

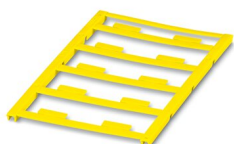

---

## UC-EMLP (15X5) SR - Plastic label

0828095

<https://www.phoenixcontact.com/us/products/0828095>

Plastic label, Sheet, silver, unlabeled, can be labeled with: BLUEMARK ID COLOR, BLUEMARK ID, BLUEMARK CLED, PLOTMARK, CMS-P1-PLOTTER, mounting type: adhesive, lettering field size: 15 x 5 mm, Number of individual labels: 10

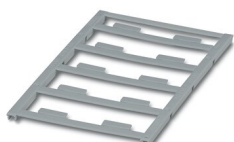

# MINI MCR-2-V8-MOD-RTU - Communication module



2905634

<https://www.phoenixcontact.com/us/products/2905634>

## UC-EMLP (15X5) SR CUS - Plastic label

0828099

<https://www.phoenixcontact.com/us/products/0828099>



Plastic label, can be ordered: by sheet, silver, labeled according to customer specifications, mounting type: adhesive, lettering field size: 15 x 5 mm, Number of individual labels: 10

---

## US-EMLP (15X5) - Plastic label

0828790

<https://www.phoenixcontact.com/us/products/0828790>



Plastic label, Card, white, unlabeled, can be labeled with: BLUEMARK ID COLOR, BLUEMARK ID, THERMOMARK PRIME, THERMOMARK CARD 2.0, THERMOMARK CARD, mounting type: adhesive, lettering field size: 15 x 5 mm, Number of individual labels: 189

# MINI MCR-2-V8-MOD-RTU - Communication module



2905634

<https://www.phoenixcontact.com/us/products/2905634>

## US-EMLP (15X5) YE - Plastic label

0828873

<https://www.phoenixcontact.com/us/products/0828873>



Plastic label, Card, yellow, unlabeled, can be labeled with: BLUEMARK ID COLOR, BLUEMARK ID, THERMOMARK PRIME, THERMOMARK CARD 2.0, THERMOMARK CARD, mounting type: adhesive, lettering field size: 15 x 5 mm, Number of individual labels: 189

---

## US-EMLP (15X5) SR - Plastic label

0828874

<https://www.phoenixcontact.com/us/products/0828874>



Plastic label, Card, silver, unlabeled, can be labeled with: BLUEMARK ID COLOR, BLUEMARK ID, THERMOMARK PRIME, THERMOMARK CARD 2.0, THERMOMARK CARD, mounting type: adhesive, lettering field size: 15 x 5 mm, Number of individual labels: 189

# MINI MCR-2-V8-MOD-RTU - Communication module



2905634

<https://www.phoenixcontact.com/us/products/2905634>

## US-EMLP (15X5) CUS - Plastic label

0830076

<https://www.phoenixcontact.com/us/products/0830076>

Plastic label, can be ordered: by card, white, labeled according to customer specifications, mounting type: adhesive, lettering field size: 15 x 5 mm, Number of individual labels: 189



---

## US-EMLP (15X5) YE CUS - Plastic label

0830077

<https://www.phoenixcontact.com/us/products/0830077>

Plastic label, can be ordered: by card, yellow, labeled according to customer specifications, mounting type: adhesive, lettering field size: 15 x 5 mm, Number of individual labels: 189



# MINI MCR-2-V8-MOD-RTU - Communication module



2905634

<https://www.phoenixcontact.com/us/products/2905634>

## US-EMLP (15X5) SR CUS - Plastic label

0830078

<https://www.phoenixcontact.com/us/products/0830078>

Plastic label, can be ordered: by card, silver, labeled according to customer specifications, mounting type: adhesive, lettering field size: 15 x 5 mm, Number of individual labels: 189



---

## UCT-EM (30X5) YE - Marker for end clamp

0830340

<https://www.phoenixcontact.com/us/products/0830340>

Marker for end clamp, Sheet, yellow, unlabeled, can be labeled with: TOPMARK NEO, TOPMARK LASER, BLUEMARK ID COLOR, BLUEMARK ID, BLUEMARK CLED, THERMOMARK PRIME, THERMOMARK CARD 2.0, THERMOMARK CARD, mounting type: snapped, lettering field size: 30 x 5 mm, Number of individual labels: 24



# MINI MCR-2-V8-MOD-RTU - Communication module



2905634

<https://www.phoenixcontact.com/us/products/2905634>

## UCT-EM (30X5) YE CUS - Marker for end clamp

0830348

<https://www.phoenixcontact.com/us/products/0830348>

Marker for end clamp, can be ordered: by sheet, yellow, labeled according to customer specifications, mounting type: snapped into marker carrier, lettering field size: 30 x 5 mm, Number of individual labels: 24



---

## SZS 0,6X3,5 - Screwdriver

1205053

<https://www.phoenixcontact.com/us/products/1205053>

Actuation tool, for ST terminal blocks, insulated, also suitable for use as a bladed screwdriver, size: 0.6 x 3.5 x 100 mm, 2-component grip, with non-slip grip



---

Phoenix Contact 2023 © - all rights reserved  
<https://www.phoenixcontact.com>

Phoenix Contact USA  
586 Fulling Mill Road  
Middletown, PA 17057, United States  
(+717) 944-1300  
[info@phoenixcon.com](mailto:info@phoenixcon.com)